



DEFREMM



Standard products 2019 edition

MATERIALE / MATERIALS

- S ACCIAIO ZINCATO: UNI EN 10263-2 / ZINC PLATED STEEL: UNI EN 10263-2
- I ACCIAIO INOX AISI 304: UNI EN 10263-5 / STAINLESS STEEL AISI 304: UNI EN 10263-5

TIPO GAMBO / SHANK TYPE

- L GAMBO LISCIO / FLAT SHANK
- S GAMBO ZIGRINATO / KNURLED SHANK
- E GAMBO PARZIALMENTE ESAGONALE / PARTIALLY HEXAGONAL SHANK
- TE GAMBO TUTTO ESAGONALE / ALL HEXAGONAL SHANK

TIPO TESTA RIVETTO / HEAD TYPE OF RIVET

- TC TESTA CILINDRICA / CYLINDRICAL HEAD
- FL TESTA FILO LAMIERA / REDUCED HEAD
- TS TESTA SVASATA A 90° / COUNTERSUNK HEAD 90°

LETTURA CODICE / IDENTIFICATION CODE : esempio / example

S1 M6 E(TE) FL C



L'azienda si riserva la facoltà di apportare modifiche sui prodotti inseriti in questo listino atte a migliorarne la qualità senza preavviso alcuno
 We reserve the right to modify, without notice, the items shown in our catalogue in order to improve their quality

1 AVVITAMENTO / SCREW

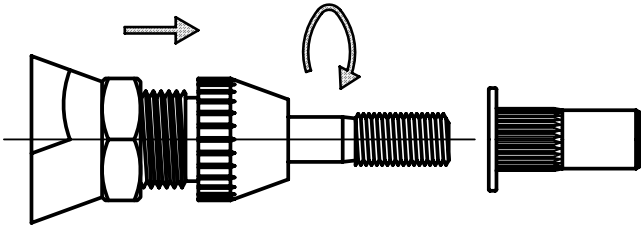

2 INTRODUZIONE / INSERT

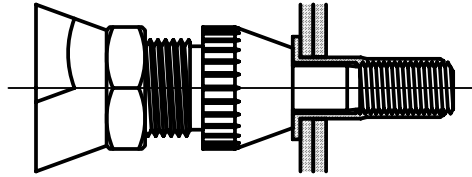

3 SERRAGGIO / TIGHTEN

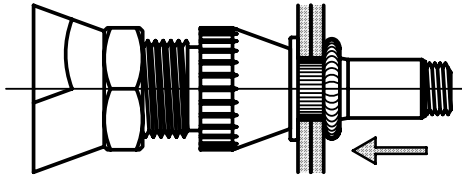

4 SVITAMENTO / UNSCREW

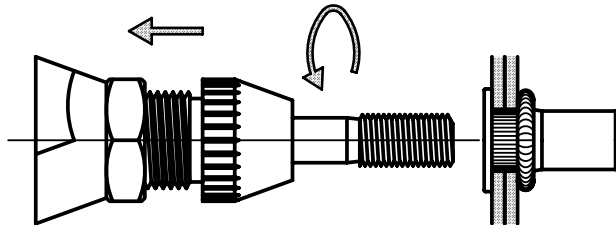

S1 M STC S2 M STC

RIVETTO TUBOLARE FILETTATO APERTO IN ACCIAIO ZINCATO - GAMBO ZIGRINATO TESTA CILINDRICA
ZINC PLATED STEEL THREADED TUBULAR INSERT OPEN - KNURLED SHANK CYLINDRICAL HEAD

C4C (1.0303)

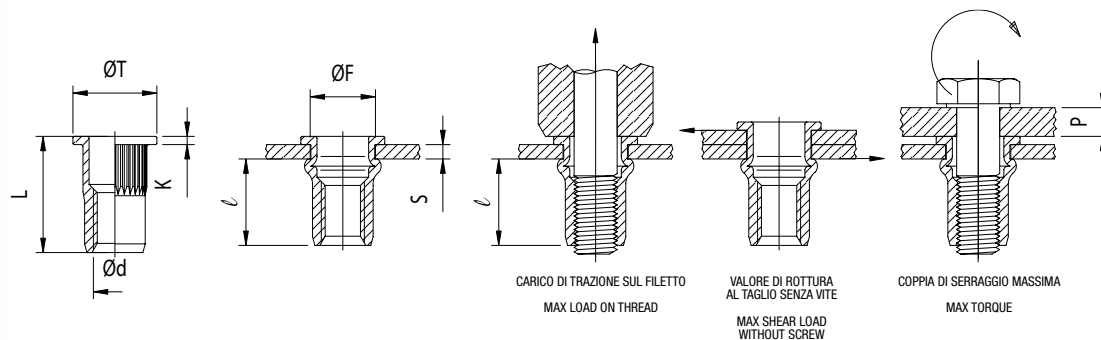

CARICO DI TRAZIONE SUL FILETTO
MAX LOAD ON THREAD

VALORE DI ROTTURA
AL TAGLIO SENZA VITE
MAX SHEAR LOAD
WITHOUT SCREW

COPIA DI SERRAGGIO MASSIMA
MAX TORQUE

MATERIALE / MATERIAL:

ACCIAIO / STEEL UNI EN 10263-2

TRATTAMENTO SUPERFICIALE / SURFACE TREATMENT:

ZINCATURA / ZINC PLATED UNI ISO 2081

FILETTATURA / THREAD:

METRICA / METRIC ISO DIN - 13 TOLL. ISO 2

Dati ottenuti dalle prove eseguite nel nostro laboratorio qualità

Le misure sono da considerarsi indicative del valore nominale della quota

Figures obtained from tests carried out by our quality lab

The measures shown in the table are to be considered as indicative of the normal value dimension

CODICE CODE	Ø d	F (+0.1)	Ø T	K	L	S	ℓ max	FILETTO THREAD	Carico a posa (N) Applied load (N)	Carico a strappo (N) Tearing load (N)	Taglio (N) Shear St. (N)	Coppia max (Nm) Max Torque (Nm)	Foro di P P hole	Spessore di P P thickness
S1 M3 STC	M3	5	8	0.8	9.5	0.5 - 2.0	5	M3 x 0.5	1800	4000	1500	1	3.1	1.0
S1 M4 STC	M4	6	9	0.8	11.5	0.5 - 2.0	6	M4 x 0.7	3500	6000	2000	3	4.1	1.0
S1 M5 STC	M5	7	10	1.0	13.5	0.5 - 3.0	8	M5 x 0.8	5000	9000	3000	6	5.1	1.0
S1 M6 STC	M6	9	12	1.2	16.0	0.5 - 3.0	10	M6 x 1.0	11000	15000	4300	10	6.1	1.0
S1 M8 STC	M8	11	16	1.4	17.5	0.5 - 3.5	12	M8 x 1.25	13000	26000	5600	24	8.2	1.5
S1 M10 STC	M10	13	17	2.0	22.0	1.0 - 3.5	15	M10 x 1.5	15000	35000	6500	45	10.2	1.5
S2 M4 STC	M4	6	9	0.8	13.0	2.0 - 4.5	6							
S2 M5 STC	M5	7	10	1.0	16.0	2.0 - 5.5	8							
S2 M6 STC	M6	9	12	1.2	18.5	2.0 - 5.5	10							
									+ / - 10%	+ / - 10%	+ / - 10%	+ / - 10%		

S1 M SFL

S2 M SFL

RIVETTO TUBOLARE FILETTATO APERTO IN ACCIAIO ZINCATO - GAMBO ZIGRINATO TESTA FILO LAMIERA
 ZINC PLATED STEEL THREADED TUBULAR INSERT OPEN - KNURLED SHANK REDUCED HEAD

C4C (1.0303)

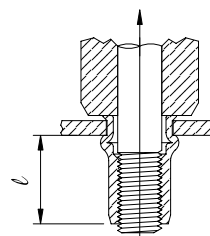
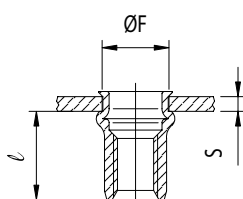
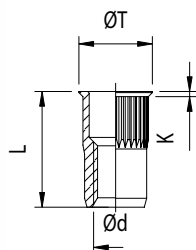

CARICO DI TRAZIONE SUL FILETTO
MAX LOAD ON THREAD

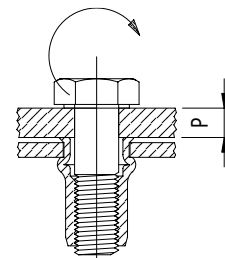

COPPIA DI SERRAGGIO MASSIMA
MAX TORQUE

MATERIALE / MATERIAL:

ACCIAIO / STEEL UNI EN 10263-2

TRATTAMENTO SUPERFICIALE / SURFACE TREATMENT:

ZINCATURA / ZINC PLATED UNI ISO 2081

FILETTATURA / THREAD:

METRICA / METRIC ISO DIN - 13 TOLL. ISO 2

Dati ottenuti dalle prove eseguite nel nostro laboratorio qualità

Le misure sono da considerarsi indicative del valore nominale della quota

Figures obtained from tests carried out by our quality lab

The measures shown in the table are to be considered as indicative of the normal value dimension

CODICE CODE	Ø d	F (+0.1)	Ø T	K	L	S	ℓ max	FILETTO THREAD	Carico a posa (N) Applied load (N)	Carico a strappo (N) Tearing load (N)	Coppia max (Nm) Max Torque (Nm)	Foro di P P hole	Spessore di P P thickness
S1 M3 SFL	M3	5	5.5	0.4	10.0	0.5 - 2.0	5	M3 x 0.5	1800	4000	1	3.1	1.0
S1 M4 SFL	M4	6	6.7	0.5	11.2	0.5 - 2.0	6	M4 x 0.7	3500	6000	3	4.1	1.0
S1 M5 SFL	M5	7	8.0	0.5	13.3	0.5 - 3.0	8	M5 x 0.8	5000	9000	6	5.1	1.0
S1 M6 SFL	M6	9	10.0	0.6	15.5	0.5 - 3.0	10	M6 x 1.0	11000	15000	10	6.1	1.0
S1 M8 SFL	M8	11	12.0	0.6	16.7	0.5 - 3.5	12	M8 x 1.25	13000	26000	24	8.2	1.5
S1 M10 SFL	M10	13	14.0	0.7	21.0	1.0 - 3.5	15	M10 x 1.5	15000	35000	45	10.2	1.5
S2 M3 SFL	M3	5	5.5	0.4	11.5	1.5 - 3.5	5						
S2 M4 SFL	M4	6	6.7	0.5	13.2	2.0 - 4.5	6						
S2 M5 SFL	M5	7	8.0	0.5	15.8	2.0 - 5.5	8						
S2 M6 SFL	M6	9	10.0	0.6	18.0	2.0 - 5.5	10						
S2 M8 SFL	M8	11	12.0	0.6	19.7	2.5 - 6.5	12						
									+ / - 10%	+ / - 10%	+ / - 10%		

S1 M LTC

RIVETTO TUBOLARE FILETTATO APERTO IN ACCIAIO ZINCATO - GAMBO LISCIO TESTA CILINDRICA
ZINC PLATED STEEL THREADED TUBULAR INSERT OPEN - FLAT SHANK CYLINDRICAL HEAD

C4C (1.0303)

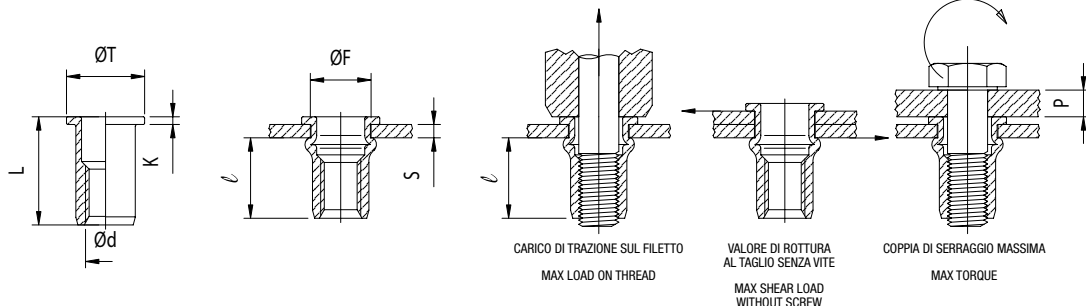

MATERIALE / MATERIAL:

ACCIAIO / STEEL UNI EN 10263-2

TRATTAMENTO SUPERFICIALE / SURFACE TREATMENT:

ZINCATURA / ZINC PLATED UNI ISO 2081

FILETTATURA / THREAD:

METRICA / METRIC ISO DIN - 13 TOLL. ISO 2

Dati ottenuti dalle prove eseguite nel nostro laboratorio qualità
Le misure sono da considerarsi indicative del valore nominale della quota
Figures obtained from tests carried out by our quality lab

The measures shown in the table are to be considered as indicative of the normal value dimension

CODICE CODE	Ø d	F (+0.1)	Ø T	K	L	S	ℓ max	FILETTO THREAD	Carico a posa (N) Applied load (N)	Carico a strappo (N) Tearing load (N)	Taglio (N) Shear St. (N)	Coppia max (Nm) Max Torque (Nm)	Foro di P P hole	Spessore di P P thickness
S1 M4 LTC	M4	6	8.5	0.8	10.5	0.5 - 2.0	6.0	M4 x 0.7	3500	6000	2000	3	4.1	1.0
S1 M5 LTC	M5	7	10.0	1.0	13.5	0.5 - 2.5	8.0	M5 x 0.8	6000	9000	3000	6	5.1	1.0
S1 M6 LTC	M6	9	12.0	1.2	16.0	0.5 - 3.0	10.0	M6 x 1.0	11000	15000	4300	10	6.1	1.0
S1 M8 LTC	M8	11	16.0	1.4	18.5	1.0 - 3.5	12.0	M8 x 1.25	13000	26000	5600	24	8.2	1.5
S1 M10 LTC	M10	13	16.3	1.6	17.0	1.0 - 3.0	11.5	M10 x 1.5	15000	35000	6500	45	10.2	1.5
									+ / - 10%	+ / - 10%	+ / - 10%	+ / - 10%		

S1 M LFL

RIVETTO TUBOLARE FILETTATO APERTO IN ACCIAIO ZINCATO - GAMBO LISCIO TESTA FILO LAMIERA
ZINC PLATED STEEL THREADED TUBULAR INSERT OPEN - FLAT SHANK REDUCED HEAD

C4C (1.0303)

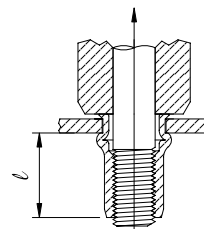
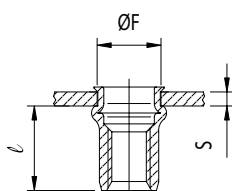
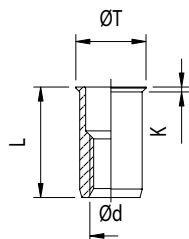

CARICO DI TRAZIONE SUL FILETTO
MAX LOAD ON THREAD

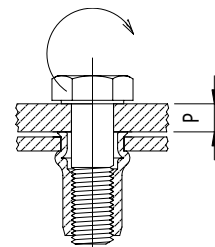

COPPIA DI SERRAGGIO MASSIMA
MAX TORQUE

MATERIALE / MATERIAL:

ACCIAIO / STEEL UNI EN 10263-2

TRATTAMENTO SUPERFICIALE / SURFACE TREATMENT:

ZINCATURA / ZINC PLATED UNI ISO 2081

FILETTATURA / THREAD:

METRICA / METRIC ISO DIN - 13 TOLL. ISO 2

Dati ottenuti dalle prove eseguite nel nostro laboratorio qualità
Le misure sono da considerarsi indicative del valore nominale della quota
Figures obtained from tests carried out by our quality lab

The measures shown in the table are to be considered as indicative of the normal value dimension

CODICE CODE	Ø d	F (+0.1)	Ø T	K	L	S	ℓ max	FILETTO THREAD	Carico a posa (N) Applied load (N)	Carico a strappo (N) Tearing load (N)	Coppia max (Nm) Max Torque (Nm)	Foro di P P hole	Spessore di P P thickness
S1 M4 LFL	M4	6	7	0.5	10.5	0.5 - 2.0	6.5	M4 x 0.7	3500	6000	3	4.1	1.0
S1 M5 LFL	M5	7	8	0.5	13.3	0.5 - 2.5	8.0	M5 x 0.8	6000	9000	6	5.1	1.0
S1 M6 LFL	M6	9	10	0.6	15.5	0.5 - 3.0	10.0	M6 x 1.0	11000	15000	10	6.1	1.0
S1 M8 LFL	M8	11	12	0.6	17.5	0.5 - 3.5	12.0	M8 x 1.25	13000	26000	24	8.2	1.5
S1 M10 LFL	M10	13	14	0.7	17.5	1.0 - 3.0	12.0	M10 x 1.5	15000	35000	45	10.2	1.5
									+ / - 10%	+ / - 10%	+ / - 10%		

S1 M STS

RIVETTO TUBOLARE FILETTATO APERTO IN ACCIAIO ZINCATO - GAMBO ZIGRINATO TESTA SVASATA A 90°
ZINC PLATED STEEL THREADED TUBULAR INSERT OPEN - KNURLED SHANK COUNTERSUNK HEAD 90°

C4C (1.0303)

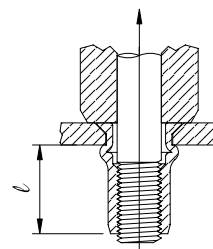
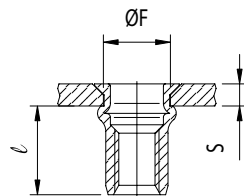
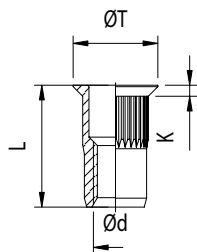

CARICO DI TRAZIONE SUL FILETTO
MAX LOAD ON THREAD

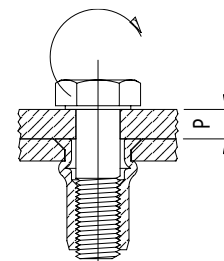

COPPIA DI SERRAGGIO MASSIMA
MAX TORQUE

MATERIALE / MATERIAL:

ACCIAIO / STEEL UNI EN 10263-2

TRATTAMENTO SUPERFICIALE / SURFACE TREATMENT:

ZINCATURA / ZINC PLATED UNI ISO 2081

FILETTATURA / THREAD:

METRICA / METRIC ISO DIN - 13 TOLL. ISO 2

Dati ottenuti dalle prove eseguite nel nostro laboratorio qualità
Le misure sono da considerarsi indicative del valore nominale della quota
Figures obtained from tests carried out by our quality lab

The measures shown in the table are to be considered as indicative of the normal value dimension

CODICE CODE	Ø d	F (+0.1)	Ø T	K	L	S	l max	FILETTO THREAD	Carico a posa (N) Applied load (N)	Carico a strappo (N) Tearing load (N)	Coppia max (Nm) Max Torque (Nm)	Foro di P P hole	Spessore di P P thickness
S1 M5 STS	M5	7	9.5	1.5	14.0	2.0 - 4.5	8	M5 x 0.8	5000	9000	6	5.1	1.0
S1 M6 STS	M6	9	11.5	1.5	16.5	2.0 - 4.5	10	M6 x 1.0	11000	15000	10	6.1	1.0
S1 M8 STS	M8	11	13.5	1.5	17.5	2.0 - 5.0	12	M8 x 1.25	13000	26000	24	8.2	1.5
									+ / - 10%	+ / - 10%	+ / - 10%		

S1 M TEFL

RIVETTO TUBOLARE FILETTATO APERTO IN ACCIAIO ZINCATO - TUTTO ESAGONALE TESTA FILO LAMIERA
ZINC PLATED STEEL THREADED TUBULAR INSERT OPEN - ALL HEXAGONAL SHANK REDUCED HEAD

C4C (1.0303)

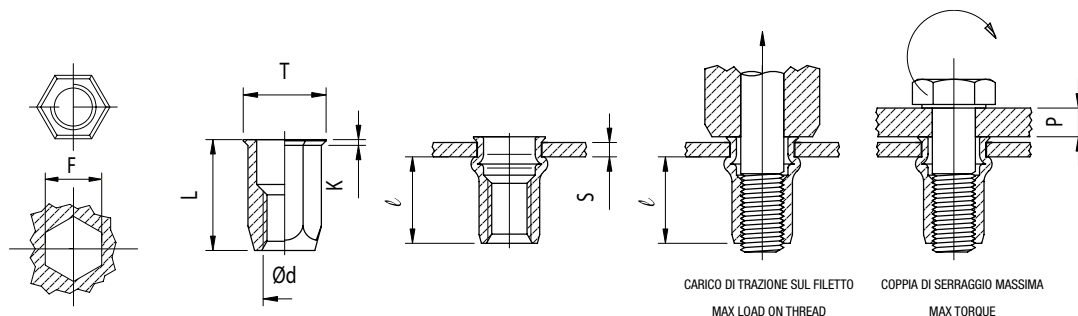

MATERIALE / MATERIAL:

ACCIAIO / STEEL UNI EN 10263-2

TRATTAMENTO SUPERFICIALE / SURFACE TREATMENT:

ZINCATURA / ZINC PLATED UNI ISO 2081

FILETTATURA / THREAD:

METRICA / METRIC ISO DIN - 13 TOLL. ISO 2

Dati ottenuti dalle prove eseguite nel nostro laboratorio qualità
Le misure sono da considerarsi indicative del valore nominale della quota
Figures obtained from tests carried out by our quality lab

The measures shown in the table are to be considered as indicative of the normal value dimension

CODICE CODE	Ø d	F (+0.1)	Ø T	K	L	S	ℓ max	FILETTO THREAD	Carico a posa (N) Applied load (N)	Carico a strappo (N) Tearing load (N)	Coppia max (Nm) Max Torque (Nm)	Foro di P P hole	Spessore di P P thickness
S1M4TEFL	M4	6	7.0	0.5	11	0.5 - 2.0	6.7	M4 x 0.7	4500	6000	3	4.1	1.0
S1M5TEFL	M5	7	8.0	0.5	14	0.5 - 3.0	8.0	M5 x 0.8	7000	9000	6	5.1	1.0
S1M6TEFL	M6	9	10.0	0.6	16	0.5 - 3.0	10.0	M6 x 1.0	10000	15000	10	6.1	1.0
S1M8TEFL	M8	11	12.0	0.7	18	0.5 - 3.5	12.0	M8 x 1.25	13000	26000	24	8.2	1.5
S1M10TEFL	M10	13	14.5	1.0	19	0.5 - 3.5	19.0	M10 x 1.5	15000	35000	45	10.2	1.5
									+ / - 10%	+ / - 10%	+ / - 10%		

S1 M ETC

RIVETTO TUBOLARE FILETTATO APERTO IN ACCIAIO ZINCATO - GAMBO PARZIALMENTE ESAGONALE TESTA CILINDRICA
ZINC PLATED STEEL THREADED TUBULAR INSERT OPEN - PARTIALLY HEXAGONAL SHANK CYLINDRICAL HEAD

C4C (1.0303)

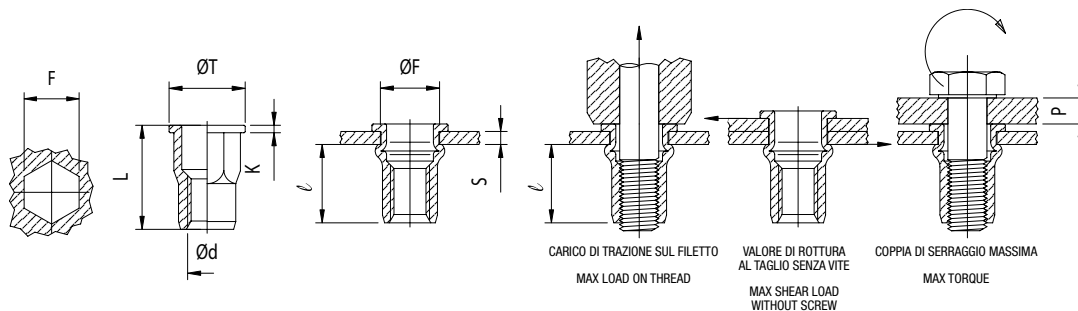

MATERIALE / MATERIAL:

ACCIAIO / STEEL UNI EN 10263-2

TRATTAMENTO SUPERFICIALE / SURFACE TREATMENT:

ZINCATURA / ZINC PLATED UNI ISO 2081

FILETTATURA / THREAD:

METRICA / METRIC ISO DIN - 13 TOLL. ISO 2

Dati ottenuti dalle prove eseguite nel nostro laboratorio qualità

Le misure sono da considerarsi indicative del valore nominale della quota

Figures obtained from tests carried out by our quality lab

The measures shown in the table are to be considered as indicative of the normal value dimension

CODICE CODE	Ø d	F (+0.1)	Ø T	K	L	S	ℓ max	FILETTO THREAD	Carico a posa (N) Applied load (N)	Carico a strappo (N) Tearing load (N)	Taglio (N) Shear St. (N)	Coppia max (Nm) Max Torque (Nm)	Foro di P P hole	Spessore di P P thickness
S1 M4 ETC	M4	6	9	0.8	11.5	0.5 - 2.0	6	M4 x 0.7	4500	6000	2000	3	4.1	1.0
S1 M5 ETC	M5	7	10	1.0	13.5	0.5 - 3.0	8	M5 x 0.8	6000	9000	3000	6	5.1	1.0
S1 M6 ETC	M6	9	12	1.2	16.0	0.5 - 3.0	10	M6 x 1.0	11000	15000	4300	10	6.1	1.0
S1 M8 ETC	M8	11	16	1.4	17.5	0.5 - 3.5	12	M8 x 1.25	13000	26000	5600	24	8.2	1.5
S1 M10 ETC	M10	13	18	1.7	22.0	1.0 - 3.5	15	M10 x 1.5	15000	35000	6500	45	10.2	1.5
									+ / - 10%	+ / - 10%	+ / - 10%	+ / - 10%		

S1 M EFL

S2 M EFL

RIVETTO TUBOLARE FILETTATO APERTO IN ACCIAIO ZINCATO - GAMBO PARZIALMENTE ESAGONALE TESTA FILO LAMIERA
 ZINC PLATED STEEL THREADED TUBULAR INSERT OPEN - PARTIALLY HEXAGONAL SHANK REDUCED HEAD

C4C (1.0303)

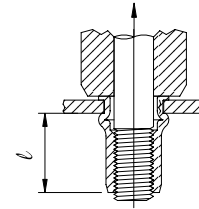
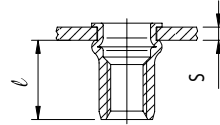
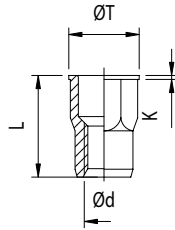
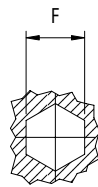

CARICO DI TRAZIONE SUL FILETTO
MAX LOAD ON THREAD

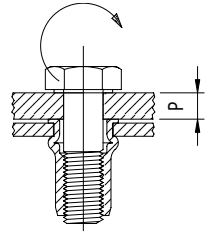

COPPIA DI SERRAGGIO MASSIMA
MAX TORQUE

MATERIALE / MATERIAL:

ACCIAIO / STEEL UNI EN 10263-2

TRATTAMENTO SUPERFICIALE / SURFACE TREATMENT:

ZINCATURA / ZINC PLATED UNI ISO 2081

FILETTATURA / THREAD:

METRICA / METRIC ISO DIN - 13 TOLL. ISO 2

Dati ottenuti dalle prove eseguite nel nostro laboratorio qualità
 Le misure sono da considerarsi indicative del valore nominale della quota

Figures obtained from tests carried out by our quality lab

The measures shown in the table are to be considered as indicative of the normal value dimension

CODICE CODE	Ø d	F (+0.1)	Ø T	K	L	S	ℓ max	FILETTO THREAD	Carico a posa (N) Applied load (N)	Carico a strappo (N) Tearing load (N)	Coppia max (Nm) Max Torque (Nm)	Foro di P P hole	Spessore di P P thickness
S1 M4 EFL	M4	6	7.2	0.5	11.2	0.5 - 2.0	6	M4 x 0.7	4500	6000	3	4.1	1.0
S1 M5 EFL	M5	7	8.2	0.5	13.3	0.5 - 3.0	8	M5 x 0.8	6000	9000	6	5.1	1.0
S1 M6 EFL	M6	9	10.5	0.6	15.3	0.5 - 3.0	10	M6 x 1.0	11000	15000	10	6.1	1.0
S1 M8 EFL	M8	11	13.0	0.7	16.7	0.5 - 3.5	12	M8 x 1.25	13000	26000	24	8.2	1.5
S1 M10 EFL	M10	13	15.0	0.8	21.0	1.0 - 3.5	15	M10 x 1.5	15000	35000	45	10.2	1.5
S2 M5 EFL	M5	7	8.2	0.5	15.8	2.0 - 5.5	8						
S2 M6 EFL	M6	9	10.5	0.6	17.8	2.0 - 5.5	10						
S2 M8 EFL	M8	11	13.0	0.7	19.7	2.5 - 6.5	12						

+ / - 10%

+ / - 10%

+ / - 10%

S1 M STC C

RIVETTO TUBOLARE FILETTATO CIECO IN ACCIAIO ZINCATO - GAMBO ZIGRINATO TESTA CILINDRICA
ZINC PLATED STEEL THREADED TUBULAR INSERT CLOSED - KNURLED SHANK CYLINDRICAL HEAD

C4C (1.0303)

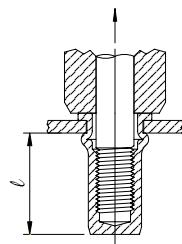
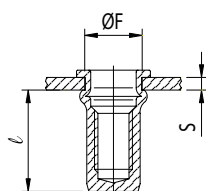
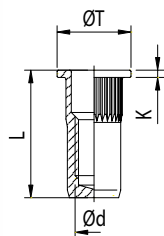

CARICO DI TRAZIONE SUL FILETTO
MAX LOAD ON THREAD

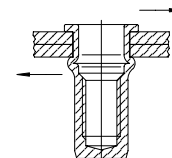

VALORE DI ROTTURA
AL TAGLIO SENZA VITE
MAX SHEAR LOAD
WITHOUT SCREW

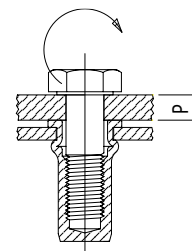

COPPIA DI SERRAGGIO MASSIMA
MAX TORQUE

MATERIALE / MATERIAL:

ACCIAIO / STEEL UNI EN 10263-2

TRATTAMENTO SUPERFICIALE / SURFACE TREATMENT:

ZINCATURA / ZINC PLATED UNI ISO 2081

FILETTATURA / THREAD:

METRICA / METRIC ISO DIN - 13 TOLL. ISO 2

Dati ottenuti dalle prove eseguite nel nostro laboratorio qualità

Le misure sono da considerarsi indicative del valore nominale della quota

Figures obtained from tests carried out by our quality lab

The measures shown in the table are to be considered as indicative of the normal value dimension

CODICE CODE	Ø d	F (+0.1)	Ø T	K	L	S	ℓ max	FILETTO THREAD	Carico a posa (N) Applied load (N)	Carico a strappo (N) Tearing load (N)	Taglio (N) Shear St. (N)	Coppia max (Nm) Max Torque (Nm)	Foro di P P hole	Spessore di P P thickness
S1 M4 STC C	M4	6	9.0	0.8	16.0	0.5 - 2.0	11.0	M4 x 0.7	3500	6000	2000	3	4.1	1.0
S1 M5 STC C	M5	7	10.0	1.0	17.0	0.5 - 3.0	11.5	M5 x 0.8	5000	9000	3000	6	5.1	1.0
S1 M6 STC C	M6	9	12.5	1.4	19.0	0.5 - 3.0	12.0	M6 x 1.0	11000	15000	4300	10	6.1	1.0
S1 M8 STC C	M8	11	15.0	1.5	21.5	0.5 - 3.0	15.0	M8 x 1.25	13000	26000	5600	24	8.2	1.5
S1 M10 STC C	M10	13	19.0	1.6	27.0	1.0 - 3.5	19.0	M10 x 1.5	15000	36000	6500	45	10.2	1.5
									+ / - 10%	+ / - 10%	+ / - 10%	+ / - 10%		

S1 M SFL C

RIVETTO TUBOLARE FILETTATO CIECO IN ACCIAIO ZINCATO - GAMBO ZIGRINATO TESTA FILO LAMIERA
ZINC PLATED STEEL THREADED TUBULAR INSERT CLOSED - KNURLED SHANK REDUCED HEAD

C4C (1.0303)

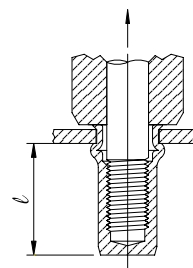
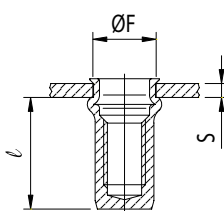
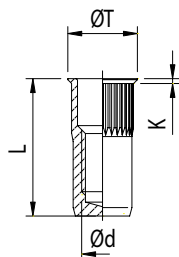

CARICO DI TRAZIONE SUL FILETTO
MAX LOAD ON THREAD

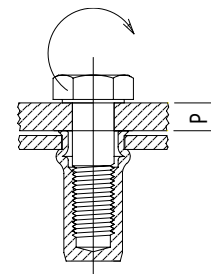

COPPIA DI SERRAGGIO MASSIMA
MAX TORQUE

MATERIALE / MATERIAL:

ACCIAIO / STEEL UNI EN 10263-2

TRATTAMENTO SUPERFICIALE / SURFACE TREATMENT:

ZINCATURA / ZINC PLATED UNI ISO 2081

FILETTATURA / THREAD:

METRICA / METRIC ISO DIN - 13 TOLL. ISO 2

Dati ottenuti dalle prove eseguite nel nostro laboratorio qualità

Le misure sono da considerarsi indicative del valore nominale della quota

Figures obtained from tests carried out by our quality lab

The measures shown in the table are to be considered as indicative of the normal value dimension

CODICE CODE	Ø d	F (+0.1)	Ø T	K	L	S	ℓ max	FILETTO THREAD	Carico a posa (N) Applied load (N)	Carico a strappo (N) Tearing load (N)	Coppia max (Nm) Max Torque (Nm)	Foro di P P hole	Spessore di P P thickness
S1 M4 SFL C	M4	6	7	0.5	15.0	0.5 - 2.0	11.0	M4 x 0.7	3500	6000	3	4.1	1.0
S1 M5 SFL C	M5	7	8	0.5	16.5	0.5 - 2.0	12.5	M5 x 0.8	5000	9000	6	5.1	1.0
S1 M6 SFL C	M6	9	10	0.6	20.5	0.5 - 3.0	15.5	M6 x 1.0	11000	15000	10	6.1	1.0
S1 M8 SFL C	M8	11	12	0.6	23.0	1.0 - 3.0	17.0	M8 x 1.25	13000	26000	24	8.2	1.5
S1 M10 SFL C	M10	13	14	0.7	24.5	1.0 - 3.0	18.0	M10 x 1.5	15000	36000	45	10.2	1.5
									+ / - 10%	+ / - 10%	+ / - 10%		

S1 M TETC C

RIVETTO TUBOLARE FILETTATO CIECO IN ACCIAIO ZINCATO - GAMBO TUTTO ESAGONALE TESTA CILINDRICA
ZINC PLATED STEEL THREADED TUBULAR INSERT CLOSED - ALL HEXAGONAL SHANK CYLINDRICAL HEAD

C4C (1.0303)

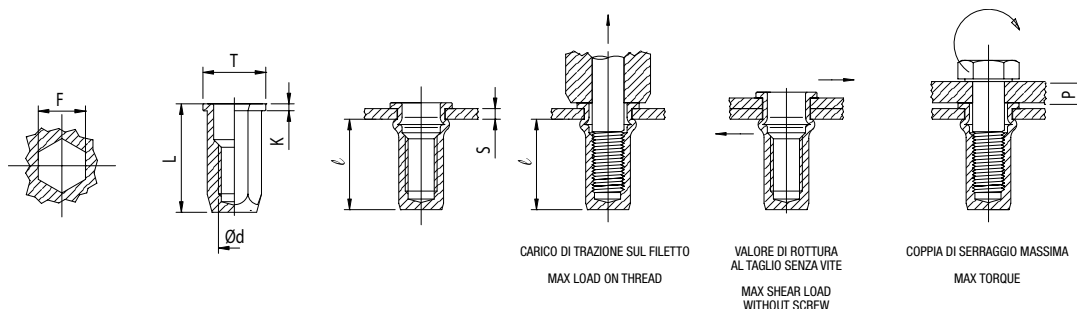

CARICO DI TRAZIONE SUL FILETTO
MAX LOAD ON THREAD

VALORE DI ROTTURA
AL TAGLIO SENZA VITE
MAX SHEAR LOAD
WITHOUT SCREW

COPPIA DI SERRAGGIO MASSIMA
MAX TORQUE

MATERIALE / MATERIAL:

ACCIAIO / STEEL UNI EN 10263-2

TRATTAMENTO SUPERFICIALE / SURFACE TREATMENT:

ZINCATURA / ZINC PLATED UNI ISO 2081

FILETTATURA / THREAD:

METRICA / METRIC ISO DIN - 13 TOLL. ISO 2

Dati ottenuti dalle prove eseguite nel nostro laboratorio qualità
Le misure sono da considerarsi indicative del valore nominale della quota
Figures obtained from tests carried out by our quality lab

The measures shown in the table are to be considered as indicative of the normal value dimension

CODICE CODE	Ø d	F (+0.1)	Ø T	K	L	S	ℓ max	FILETTO THREAD	Carico a posa (N) Applied load (N)	Carico a strappo (N) Tearing load (N)	Taglio (N) Shear St. (N)	Coppia max (Nm) Max Torque (Nm)	Foro di P P hole	Spessore di P P thickness
S1 M4 TETC C	M4	6	9.0	1.0	15.0	0.5 - 2.0	11	M4 x 0.7	4500	6000	2000	3	4.1	1.0
S1 M5 TETC C	M5	7	10.0	1.0	18.0	0.5 - 3.0	13	M5 x 0.8	6000	9000	3000	6	5.1	1.0
S1 M6 TETC C	M6	9	12.5	1.5	23.0	0.5 - 3.0	17	M6 x 1.0	11000	15000	4300	10	6.1	1.0
S1 M8 TETC C	M8	11	16.0	1.5	26.0	1.0 - 3.5	19	M8 x 1.25	13000	26000	5600	24	8.2	1.5
S1 M10 TETC C	M10	13	19.0	1.9	32.5	1.0 - 3.5	25	M10 x 1.5	15000	35000	6500	45	10.2	1.5
									+ / - 10%	+ / - 10%	+ / - 10%	+ / - 10%		

S1 M TEFL C

RIVETTO TUBOLARE FILETTATO CIECO IN ACCIAIO ZINCATO - GAMBO TUTTO ESAGONALE TESTA FILO LAMIERA
 ZINC PLATED STEEL THREADED TUBULAR INSERT CLOSED - ALL HEXAGONAL SHANK REDUCED HEAD

C4C (1.0303)

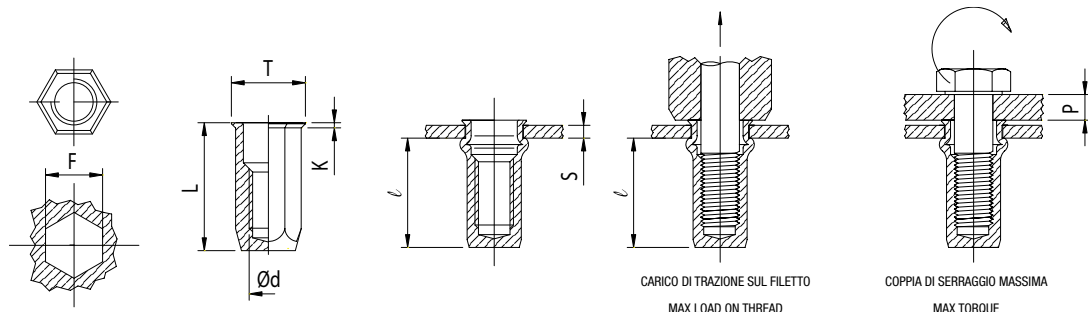

CARICO DI TRAZIONE SUL FILETTO
MAX LOAD ON THREAD

COPPIA DI SERRAGGIO MASSIMA
MAX TORQUE

MATERIALE / MATERIAL:

ACCIAIO / STEEL UNI EN 10263-2

TRATTAMENTO SUPERFICIALE / SURFACE TREATMENT:

ZINCATURA / ZINC PLATED UNI ISO 2081

FILETTATURA / THREAD:

METRICA / METRIC ISO DIN - 13 TOLL. ISO 2

Dati ottenuti dalle prove eseguite nel nostro laboratorio qualità
 Le misure sono da considerarsi indicative del valore nominale della quota

Figures obtained from tests carried out by our quality lab

The measures shown in the table are to be considered as indicative of the normal value dimension

CODICE CODE	Ø d	F (+0.1)	Ø T	K	L	S	ℓ max	FILETTO THREAD	Carico a posa (N) Applied load (N)	Carico a strappo (N) Tearing load (N)	Coppia max (Nm) Max Torque (Nm)	Foro di P P hole	Spessore di P P thickness
S1 M4 TEFL C	M4	6	7.0	0.5	16.0	0.5 - 2.0	12	M4 x 0.7	4500	6000	3	4.1	1.0
S1 M5 TEFL C	M5	7	8.0	0.5	20.0	0.5 - 3.0	14	M5 x 0.8	6000	9000	6	5.1	1.0
S1 M6 TEFL C	M6	9	10.0	0.6	20.5	0.5 - 3.0	14	M6 x 1.0	11000	15000	10	6.1	1.0
S1 M8 TEFL C	M8	11	12.0	0.6	23.0	0.5 - 3.5	21	M8 x 1.25	13000	26000	24	8.2	1.5
S1 M10 TEFL C	M10	13	14.5	0.7	28.5	1.0 - 3.5	21	M10 x 1.5	15000	35000	45	10.2	1.5
									+ / - 10%	+ / - 10%	+ / - 10%		

I1 M STC I2 M STC

RIVETTO TUBOLARE FILETTATO APERTO IN ACCIAIO INOSSIDABILE - GAMBO ZIGGINATO TESTA CILINDRICA
STAINLESS STEEL THREADED TUBULAR INSERT OPEN - KNURLED SHANK CYLINDRICAL HEAD

AISI 304 (1.4567)

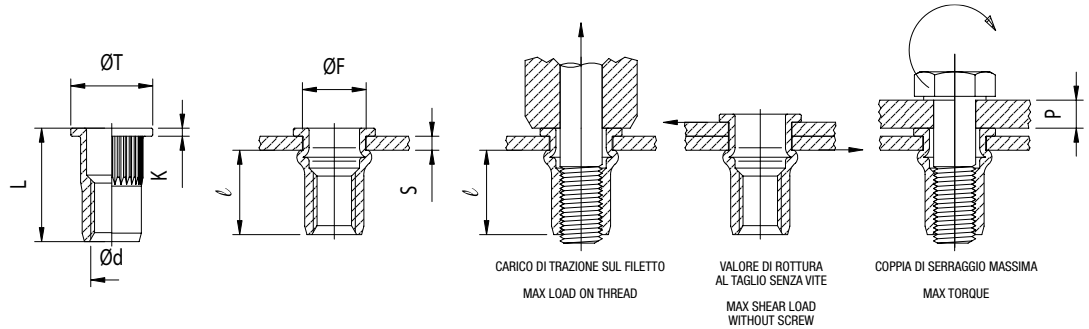

MATERIALE / MATERIAL:

ACCIAIO INOX / STAINLESS STEEL UNI EN ISO 10263-5

Dati ottenuti dalle prove eseguite nel nostro laboratorio qualità
Le misure sono da considerarsi indicative del valore nominale della quota
Figures obtained from tests carried out by our quality lab

FILETTATURA / THREAD:

METRICA METRIC ISO DIN 13 - TOLL. ISO 2

The measures shown in the table are to be considered as indicative of the normal value dimension

CODICE CODE	Ø d	F (+0.1)	Ø T	K	L	S	ℓ max	FILETTO THREAD	Carico a posa (N) Applied load (N)	Carico a strappo (N) Tearing load (N)	Taglio (N) Shear St. (N)	Coppia max (Nm) Max Torque (Nm)	Foro di P P hole	Spessore di P P thickness
I1 M4 STC	M4	6	9	0.8	11.5	0.5 - 2.0	6	M4 x 0.7	6000	9000	3500	7	4.1	1.0
I1 M5 STC	M5	7	10	1.0	13.5	0.5 - 3.0	8	M5 x 0.8	8000	12000	5500	11	5.1	1.0
I1 M6 STC	M6	9	12	1.2	16.0	0.5 - 3.0	10	M6 x 1.0	16000	23000	8000	21	6.1	1.0
I1 M8 STC	M8	11	15	1.4	17.5	0.5 - 3.5	12	M8 x 1.25	18000	30000	11000	35	8.2	1.5
I1 M10 STC	M10	13	17	2.0	22.0	1.0 - 3.5	15	M10 x 1.5	25000	38000	15000	50	10.2	1.5
I2 M6 STC	M6	9	12	1.2	18.5	2.0 - 5.5	10							

+ / - 10% + / - 10% + / - 10% + / - 10%

REALIZZABILI SU RICHIESTA ANCHE IN
ALSO AVAILABLE ON REQUEST IN

AISI 316
(1.4401 / 1.4404)

I1 M SFL I2 M SFL

RIVETTO TUBOLARE FILETTATO APERTO IN ACCIAIO INOSSIDABILE - GAMBO ZIGGINATO TESTA FILO LAMIERA
STAINLESS STEEL THREADED TUBULAR INSERT OPEN - KNURLED SHANK REDUCED HEAD

AISI 304 (1.4567)

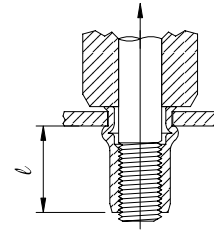
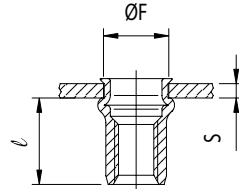
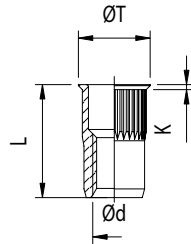

CARICO DI TRAZIONE SUL FILETTO
MAX LOAD ON THREAD

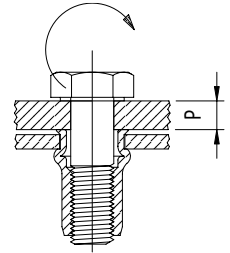

COPPIA DI SERRAGGIO MASSIMA
MAX TORQUE

MATERIALE / MATERIAL:

ACCIAIO INOX / STAINLESS STEEL UNI EN ISO 10263-5

Dati ottenuti dalle prove eseguite nel nostro laboratorio qualità
Le misure sono da considerarsi indicative del valore nominale della quota
Figures obtained from tests carried out by our quality lab

FILETTATURA / THREAD:

METRICA METRIC ISO DIN 13 - TOLL. ISO 2

The measures shown in the table are to be considered as indicative of the normal value dimension

CODICE CODE	Ø d	F (+0.1)	Ø T	K	L	S	l max	FILETTO THREAD	Carico a posa (N) Applied load (N)	Carico a strappo (N) Tearing load (N)	Coppia max (Nm) Max Torque (Nm)	Foro di P P hole	Spessore di P P thickness
I1 M4 SFL	M4	6	6.7	0.5	11.2	0.5 - 2.0	6	M4 x 0.7	6000	9000	7	4.1	1.0
I1 M5 SFL	M5	7	8.0	0.5	13.3	0.5 - 3.0	8	M5 x 0.8	8000	12000	11	5.1	1.0
I1 M6 SFL	M6	9	10.0	0.6	15.5	0.5 - 3.0	10	M6 x 1.0	16000	23000	21	6.1	1.0
I1 M8 SFL	M8	11	12.0	0.6	16.7	0.5 - 3.5	12	M8 x 1.25	18000	30000	35	8.2	1.5
I1 M10 SFL	M10	13	14.0	0.7	21.0	1.0 - 3.5	15	M10 x 1.5	25000	38000	50	10.2	1.5
I2 M6 SFL	M6	9	10.0	0.6	18.0	2.0 - 5.5	10						

+ / - 10%

+ / - 10%

+ / - 10%

REALIZZABILI SU RICHIESTA ANCHE IN
ALSO AVAILABLE ON REQUEST IN

AISI 316
(1.4401 / 1.4404)

I1 M ETC

RIVETTO TUBOLARE FILETTATO APERTO IN ACCIAIO INOSSIDABILE - GAMBO PARZIALMENTE ESAGONALE TESTA CILINDRICA
 STAINLESS STEEL THREADED TUBULAR INSERT OPEN - PARTIALLY HEXAGONAL SHANK CYLINDRICAL HEAD

AISI 304 (1.4567)

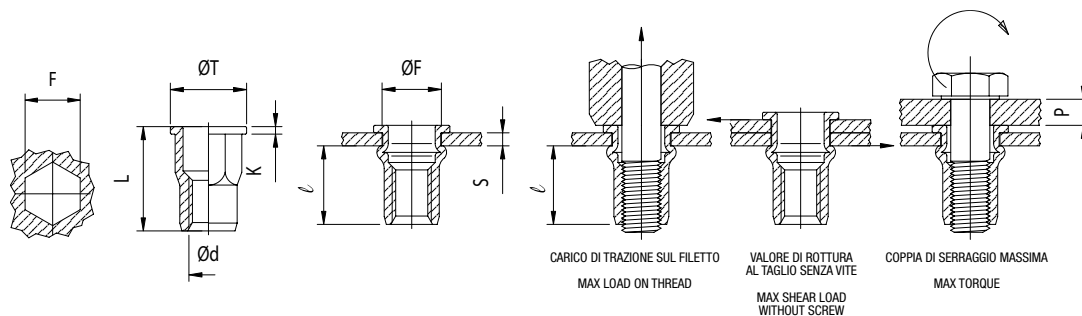

MATERIALE / MATERIAL:

ACCIAIO INOX / STAINLESS STEEL UNI EN ISO 10263-5

Dati ottenuti dalle prove eseguite nel nostro laboratorio qualità
 Le misure sono da considerarsi indicative del valore nominale della quota
 Figures obtained from tests carried out by our quality lab

FILETTATURA / THREAD:

METRICA METRIC ISO DIN 13 - TOLL. ISO 2

The measures shown in the table are to be considered as indicative of the normal value dimension

CODICE CODE	Ø d	F (+0.1)	Ø T	K	L	S	ℓ max	FILETTO THREAD	Carico a posa (N) Applied load (N)	Carico a strappo (N) Tearing load (N)	Taglio (N) Shear St. (N)	Coppia max (Nm) Max Torque (Nm)	Foro di P P hole	Spessore di P P thickness
I1 M4 ETC	M4	6	9	0.8	11.5	0.5 - 2.0	6	M4 x 0.7	6000	9000	3500	7	4.1	1.0
I1 M5 ETC	M5	7	10	1.0	13.5	0.5 - 3.0	8	M5 x 0.8	8000	12000	5500	11	5.1	1.0
I1 M6 ETC	M6	9	12	1.2	16.0	0.5 - 3.0	10	M6 x 1.0	14000	23000	8000	21	6.1	1.0
I1 M8 ETC	M8	11	15	1.4	17.5	0.5 - 3.5	12	M8 x 1.25	16000	30000	11000	35	8.2	1.5
I1 M10 ETC	M10	13	18	1.7	22.0	1.0 - 3.5	15	M10 x 1.5	25000	38000	15000	50	10.2	1.5

+ / - 10% + / - 10% + / - 10% + / - 10%

REALIZZABILI SU RICHIESTA ANCHE IN
 ALSO AVAILABLE ON REQUEST IN

AISI 316
 (1.4401 / 1.4404)

I1 M EFL

RIVETTO TUBOLARE FILETTATO APERTO IN ACCIAIO INOSSIDABILE - GAMBO PARZIALMENTE ESAGONALE TESTA FILO LAMIERA
 STAINLESS STEEL THREADED TUBULAR INSERT OPEN - PARTIALLY HEXAGONAL SHANK REDUCED HEAD

AISI 304 (1.4567)

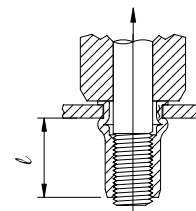
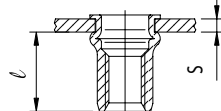
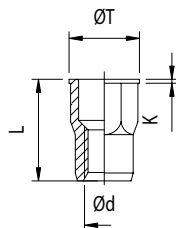
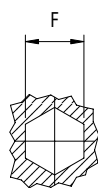

CARICO DI TRAZIONE SUL FILETTO
MAX LOAD ON THREAD

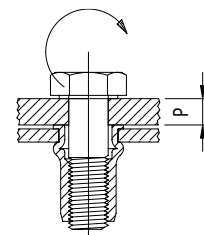

COPPIA DI SERRAGGIO MASSIMA
MAX TORQUE

MATERIALE / MATERIAL:

ACCIAIO INOX / STAINLESS STEEL UNI EN ISO 10263-5

Dati ottenuti dalle prove eseguite nel nostro laboratorio qualità
 Le misure sono da considerarsi indicative del valore nominale della quota
 Figures obtained from tests carried out by our quality lab

FILETTATURA / THREAD:

METRICA METRIC ISO DIN 13 - TOLL. ISO 2

The measures shown in the table are to be considered as indicative of the normal value dimension

CODICE CODE	Ø d	F (+0.1)	Ø T	K	L	S	ℓ max	FILETTO THREAD	Carico a posa (N) Applied load (N)	Carico a strappo (N) Tearing load (N)	Coppia max (Nm) Max Torque (Nm)	Foro di P P hole	Spessore di P P thickness
I1 M4 EFL	M4	6	7.2	0.5	11.2	0.5 - 2.0	6	M4 x 0.7	6000	9000	7	4.1	1.0
I1 M5 EFL	M5	7	8.2	0.5	13.3	0.5 - 3.0	8	M5 x 0.8	8000	12000	11	5.1	1.0
I1 M6 EFL	M6	9	10.5	0.6	15.3	0.5 - 3.0	10	M6 x 1.0	14000	23000	21	6.1	1.0
I1 M8 EFL	M8	11	13.0	0.7	16.7	0.5 - 3.5	12	M8 x 1.25	16000	30000	35	8.2	1.5
I1 M10 EFL	M10	13	15.0	0.8	21.0	1.0 - 3.5	15	M10 x 1.5	25000	38000	50	10.2	1.5

+ / - 10%

+ / - 10%

+ / - 10%

REALIZZABILI SU RICHIESTA ANCHE IN
 ALSO AVAILABLE ON REQUEST IN

AISI 316
 (1.4401 / 1.4404)

MATERIALI PER BOCCOLA / BODY MATERIALS

- A ALLUMINIO: ALMG 3,5 LEGA 5154 A / ALU ALLOY: 5154 A
- S ACCIAIO ZINCATO: UNI EN 10263-2 / ZINC PLATED STEEL: UNI EN 10263-2
- I ACCIAIO INOX AISI 304: UNI EN 10263-5 / STAINLESS STEEL AISI 304: UNI EN 10263-5
- A-MG ALLUMINIO: ALMG 2,5 LEGA 5052 / ALU ALLOY: 5052

MATERIALI PER MANDRINO / MANDREL MATERIALS

- S ACCIAIO ZINCATO / ZINC PLATED STEEL
- I ACCIAIO INOX AISI 304: UNI EN 10263-5 / STAINLESS STEEL AISI 304: UNI EN 10263-5

TIPO TESTA RIVETTO / HEAD TYPE OF RIVET

- T TONDA / DOMED
- F FRESATA 120° / COUNTERSUNK 120°
- L LARGA / LARGE
- G GRANDE / EXTRA LARGE

LETTURA CODICE / IDENTIFICATION CODE : esempio / example

AST 3210 XXXX

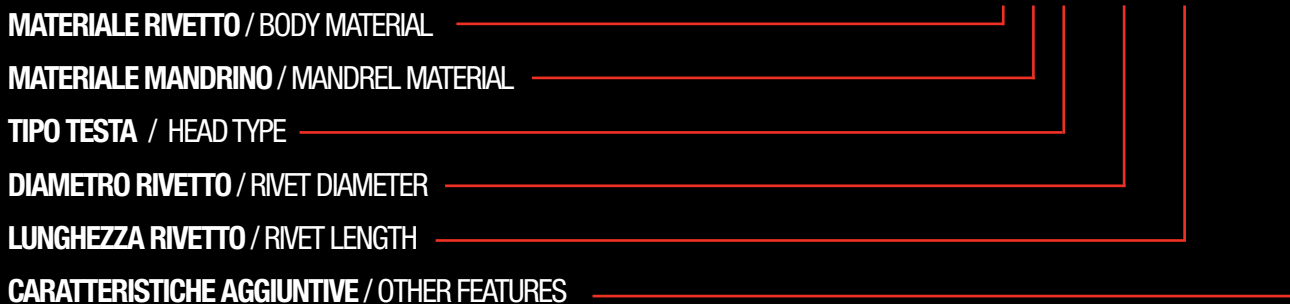

L'azienda si riserva la facoltà di apportare modifiche sui prodotti inseriti in questo listino atte a migliorarne la qualità senza preavviso alcuno
We reserve the right to modify, without notice, the items shown in our catalogue in order to improve their quality

1 INSERIMENTO / INSERT

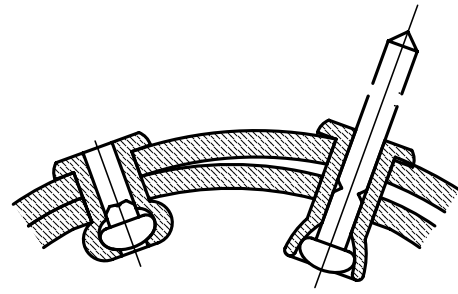
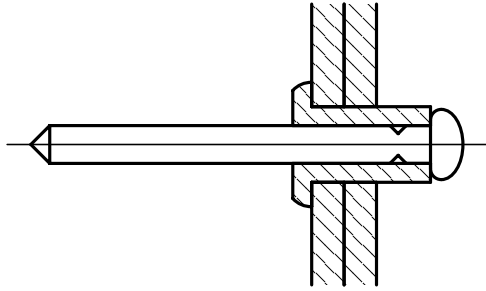

2 DEFORMAZIONE RIVETTO / RIVET DEFORMATION

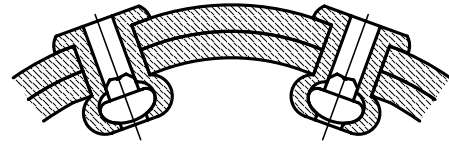
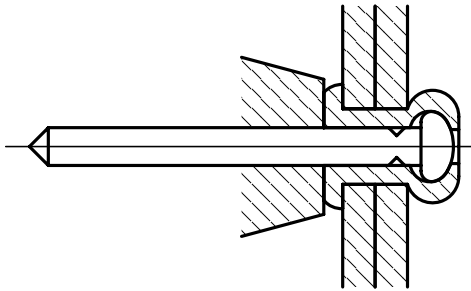

3 ROTTURA DEL CHIODO / BREAK OF THE MANDREL

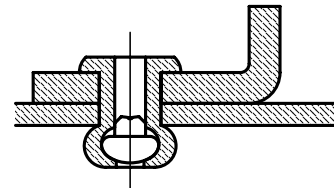
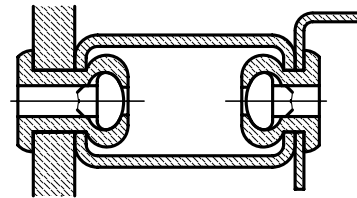
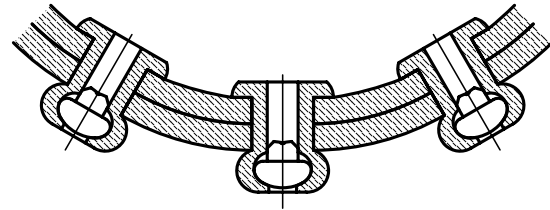
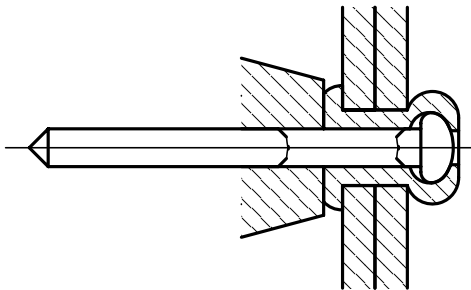

AST

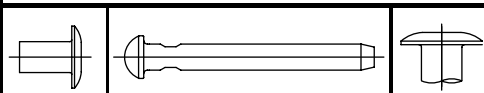
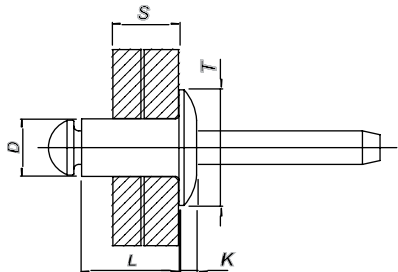

ALL
ALU

ACCIAIO
STEEL

TONDA
DOMED

D mm	 mm	L mm	S mm	T mm	K mm	Codice Code	Resistenza al taglio Shear Strength	Resistenza trazione Tensile Strength
2.4	2.5	5	0.8 - 2.5	4.8	0.7	2405	40 Kg. - 392 N	55 Kg. - 539 N
		6	2.5 - 3.5			2406		
		7	3.5 - 4.5			2407		
		9	4.5 - 6.5			2409		
3	3.1	5	1 - 2	6	0.8	2905	75 Kg. - 735 N	105 Kg. - 1029 N
		6	2 - 3			2906		
		7	3 - 4			2907		
		8	4 - 5			2908		
		9	5 - 6			2909		
		10	6 - 7			2910		
		11	7 - 8			2911		
		12	8 - 9			2912		
3.2	3.3	6	1.5 - 2.5	6.5	0.85	3206	95 Kg. - 930 N	120 Kg. - 1176 N
		7	2.5 - 3.5			3207		
		8	3.5 - 4.5			3208		
		9	4.5 - 5.5			3209		
		10	5.5 - 6.5			3210		
		11	6.5 - 7.5			3211		
		12	7.5 - 8.5			3212		
		14	8.5 - 10.5			3214		
		16	10.5 - 12.5			3216		
		4	4.1			6		
7	2 - 3			3907				
8	3 - 4			3908				
9	4 - 5			3909				
10	5 - 6			3910				
11	6 - 7			3911				
12	7 - 8			3912				
14	8 - 10			3914				
16	10 - 11			3916				
18	11 - 13			3918				
20	13 - 15			3920				
25	15 - 20			3925				
4.8	5	8	1 - 3	9.5	1.4	4808	215 Kg. - 2107 N	290 Kg. - 2842 N
		9	3 - 4			4809		
		10	4 - 5			4810		
		11	5 - 6			4811		
		12	6 - 7			4812		
		14	7 - 9			4814		
		16	9 - 11			4816		
		18	11 - 13			4818		
		20	13 - 15			4820		
		22	15 - 16			4822		
		25	16 - 19			4825		
		30	19 - 24			4830		
6	6.1	9	2 - 3	12	1.7	5909	345 Kg. - 3381 N	470 Kg. - 4606 N
		12	3 - 6			5912		
		15	6 - 9			5915		
		18	9 - 12			5918		
		22	12 - 16			5922		
		32	16 - 26			5932		
6.4	6.5	10	2 - 3	13	2	6410	370 Kg. - 3626 N	580 Kg. - 5586 N
		13	3 - 6			6413		
		16	6 - 9			6416		
		19	9 - 12			6419		
		25	12 - 18			6425		

+ / - 10%

+ / - 10%

D mm	 mm	L mm	S mm	T mm	K mm	Codice Code	Resistenza al taglio Shear Strength	Resistenza trazione Tensile Strength
2.4	2.5	6 7 9	0.8 - 3.5 3.5 - 4.5 4.5 - 6.5	4.8	0.75	2406 2407 2409	40 Kg. - 392 N	55 Kg. - 539 N
3	3.1	7 9	1 - 4 4 - 6	5.5	1	2907 2909	75 Kg. - 735 N	105 Kg. - 1029 N
3.2	3.3	8 9 12	1 - 4.5 4.5 - 5.5 5.5 - 8.5	5.8	1	3208 3209 3212	95 Kg. - 930 N	120 Kg. - 1176 N
4	4.1	8 9 10 12 14 16 18	1 - 1.5 1.5 - 2.5 2.5 - 3.5 3.5 - 5.5 5.5 - 6.5 6.5 - 7.5 7.5 - 8.5	7.5	1.1	3908 3909 3910 3912 3914 3916 3918	145 Kg. - 1421 N	205 Kg. - 2009 N
4.8	5	10 12 14 16 18 20 25	1 - 5 5 - 7 7 - 9 9 - 11 11 - 13 13 - 15 15 - 19	9	1.3	4810 4812 4814 4816 4818 4820 4825	215 Kg. - 2107 N	290 Kg. - 2842 N

+ / - 10%

+ / - 10%

D mm	 mm	L mm	S mm	T mm	K mm	Codice Code	Resistenza al taglio Shear Strength	Resistenza trazione Tensile Strength
4	4.1	9 12 14 16 20	1 - 5 5 - 8 8 - 10 10 - 11 11 - 15	12	1.5	3909 3912 3914 3916 3920	145 Kg. - 1421 N	205 Kg. - 2009 N
4.8	5	9 12 14 16 18 20 25	1 - 4 4 - 7 7 - 9 9 - 11 11 - 13 13 - 15 15 - 19	14	1.7	4809 4812 4814 4816 4818 4820 4825	215 Kg. - 2107 N	290 Kg. - 2842 N

+ / - 10%

+ / - 10%

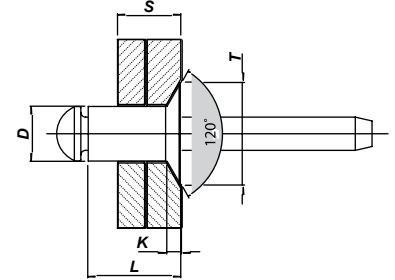
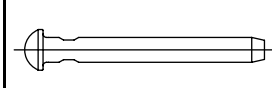
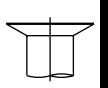
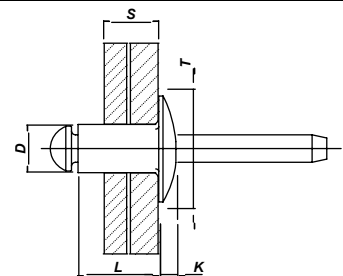
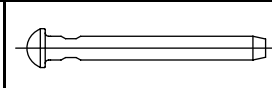
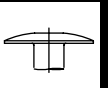
ASFALL
ALUACCIAIO
STEELFRESATA
COUNTERSUNK**ASL**ALL
ALUACCIAIO
STEELLARGA
LARGE

ASG

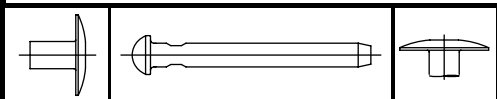
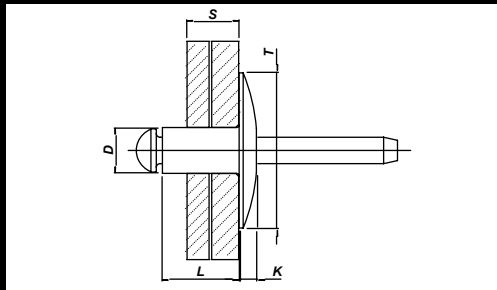

ALL
ALU

ACCIAIO
STEEL

GRANDE
EXTRA LARGE

D mm	 mm	L mm	S mm	T mm	K mm	Codice Code	Resistenza al taglio Shear Strength	Resistenza trazione Tensile Strength
4.8	5	12	1 - 7	16	1.7	4812	215 Kg. - 2107 N	290 Kg. - 2842 N
		14	7 - 9			4814		
		16	9 - 11			4816		
		18	11 - 13			4818		
		20	13 - 15			4820		
		25	15 - 19			4825		
							+ / - 10%	+ / - 10%

AIT

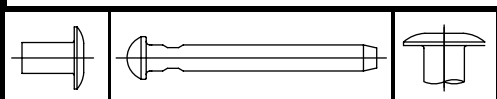
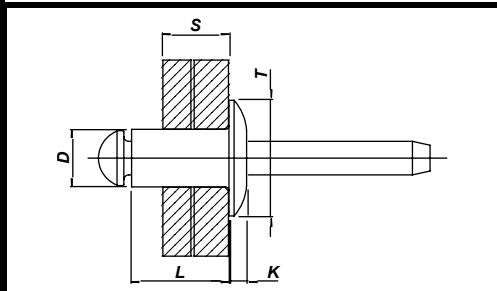

ALL
ALU

INOX 304
INOX 304

TONDA
DOMED

D mm	 mm	L mm	S mm	T mm	K mm	Codice Code	Resistenza al taglio Shear Strength	Resistenza trazione Tensile Strength
4	4.1	9	1 - 5	8	1.2	3909	145 Kg. - 1421 N	205 Kg. - 2009 N
		12	5 - 8			3912		
		16	10 - 11			3916		
4.8	5	10	1 - 5	9.5	1.4	4810	215 Kg. - 2107 N	290 Kg. - 2842 N
		12	5 - 7			4812		
		14	7 - 9			4814		
		16	9 - 11			4816		
		18	11 - 13			4818		
							+ / - 10%	+ / - 10%

D mm	 mm	L mm	S mm	T mm	K mm	Codice Code	Resistenza al taglio Shear Strength	Resistenza trazione Tensile Strength
4	4.3	12 16 20	1 - 4 4 - 8 8 - 12	8	1.2	4012 4016 4020	135 Kg. - 1323 N	170 Kg. - 1666 N
4.8	5.2	12 16 20 25	1 - 3 3 - 6 6 - 10 10 - 15	9.5	1.4	4812 4816 4820 4825	205 Kg. - 2009 N	260 Kg. - 2548 N

+ / - 10%

+ / - 10%

AST...FIOR

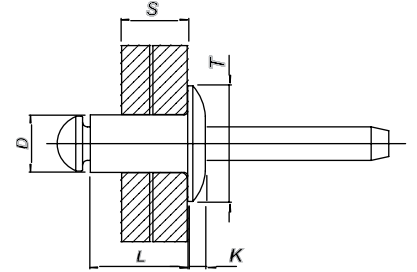

ALL
ALU

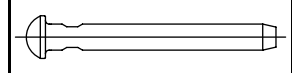

ACCIAIO
STEEL



TONDA
DOMED

SST

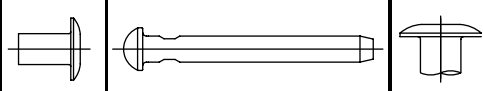
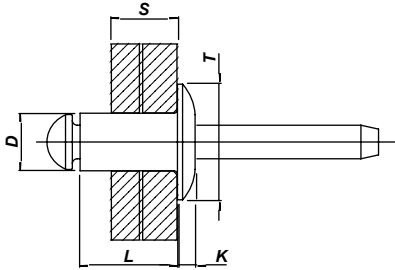

ACCIAIO
STEEL

ACCIAIO
STEEL

TONDA
DOMED

D mm	 mm	L mm	S mm	T mm	K mm	Codice Code	Resistenza al taglio Shear Strength	Resistenza trazione Tensile Strength
3	3.1	6 8 10	1 - 3 3 - 5 5 - 7	6	0.8	2906 2908 2910	115 Kg. - 1127 N	150 Kg. - 1470 N
3.2	3.3	6 7 8 9 10 11 12	1 - 2.5 2.5 - 3.5 3.5 - 4.5 4.5 - 5.5 5.5 - 6.5 6.5 - 7.5 7.5 - 8.5	6.5	0.85	3206 3207 3208 3209 3210 3211 3212	130 Kg. - 1274 N	165 Kg. - 1617 N
4	4.1	6 7 8 9 10 11 12 14 16 18	1 - 2 2 - 3 3 - 4 4 - 5 5 - 6 6 - 7 7 - 8 8 - 10 10 - 11 11 - 13	8	1.2	3906 3907 3908 3909 3910 3911 3912 3914 3916 3918	200 Kg. - 1960 N	280 Kg. - 2744 N
4.8	5	8 9 10 11 12 14 16 18 20 22 25 30	1 - 3 3 - 4 4 - 5 5 - 6 6 - 7 7 - 9 9 - 11 11 - 13 13 - 15 15 - 16 16 - 19 19 - 24	9.5	1.4	4808 4809 4810 4811 4812 4814 4816 4818 4820 4822 4825 4830	340 Kg. - 3332 N	480 Kg. - 4704 N
6	6.1	9 12 15 18 22	2 - 3 3 - 6 6 - 9 9 - 12 12 - 16	12	1.7	5909 5912 5915 5918 5922	450 Kg. - 4410 N	600 Kg. - 5880 N
6.4	6.5	10 12.5 14 15.5 19	2 - 3 3 - 5.5 5.5 - 7 7 - 8.5 8.5 - 12	13	2	6410 64125 6414 64155 6419	500 Kg. - 4900 N	720 Kg. - 7056 N

+ / - 10%

+ / - 10%

D mm	 mm	L mm	S mm	T mm	K mm	Codice Code	Resistenza al taglio Shear Strength	Resistenza trazione Tensile Strength
4	4.1	8 10 12	1 - 4 4 - 6 6 - 8	7.5	1	3908 3910 3912	200 Kg. - 1960 N	280 Kg. - 2744 N
4.8	5	10 12 14 16 18	1 - 5 5 - 7 7 - 9 9 - 11 11 - 13	9	1.3	4810 4812 4814 4816 4818	340 Kg. - 3332 N	480 Kg. - 4704 N

+ / - 10%

+ / - 10%

SSF

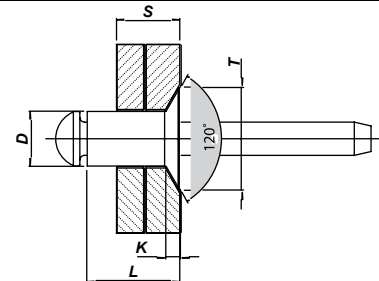

ACCIAIO
STEEL

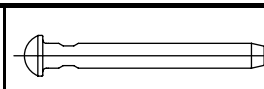

ACCIAIO
STEEL



FRESATA
COUNTERSUNK

D mm	 mm	L mm	S mm	T mm	K mm	Codice Code	Resistenza al taglio Shear Strength	Resistenza trazione Tensile Strength
3.2	3.3	6 8 10 12	0.5 - 2.5 2.5 - 4.5 4.5 - 6.5 6.5 - 8.5	6.4	1	3206 3208 3210 3212	203 Kg. - 2000 N	280 Kg. - 2750 N
4	4.1	7 10 12 14 18	1 - 3.5 3.5 - 6 6 - 8 8 - 10 10 - 14	7.8	1.2	3907 3910 3912 3914 3918	302 Kg. - 2970 N	392 Kg. - 3850 N
4.8	5	8 10 12 14 16 18 20 25	1.5 - 3.5 3.5 - 5.5 5.5 - 7.5 7.5 - 9.5 9.5 - 11.5 11.5 - 13.5 13.5 - 15.5 15.5 - 19	9.5	1.3	4808 4810 4812 4814 4816 4818 4820 4825	448 Kg. - 4400 N	560 Kg. - 5500 N

+ / - 10%

+ / - 10%

IIT

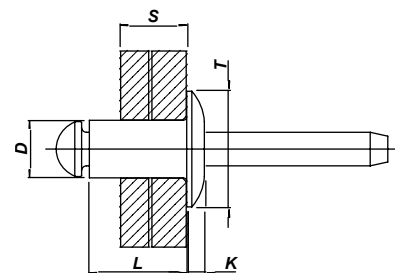

INOX 304
INOX 304

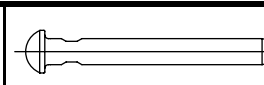

INOX 304
INOX 304



TONDA
DOMED

AST...MG

MULTI GRIP

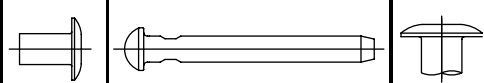
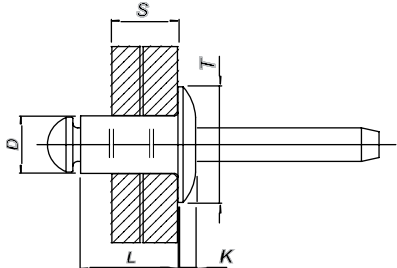

ALL
ALU

ACCIAIO
STEEL

TONDA
DOMED

D mm	 mm	L mm	S mm	T mm	K mm	Codice Code	Resistenza al taglio Shear Strength	Resistenza trazione Tensile Strength
3.2	3.3 - 4	9 12	max 6 max 9	6.5	0.85	3209 3212	75 Kg. - 735 N	100 Kg. - 981 N
4	4 - 5.5	8 12 16	max 4 max 8 max 12	8	1.2	4008 4012 4016	120 Kg. - 1177 N	180 Kg. - 1765 N
4.8	5 - 6.5	10 16 20 25	max 5 max 11 max 15 max 20	9.5	1.4	4810 4816 4820 4825	170 Kg. - 1667 N	245 Kg. - 2403 N

+ / - 10%

+ / - 10%

ASL...MG

MULTI GRIP

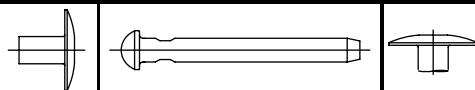
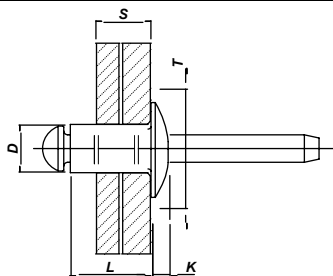

ALL
ALU

ACCIAIO
STEEL

LARGA
LARGE

D mm	 mm	L mm	S mm	T mm	K mm	Codice Code	Resistenza al taglio Shear Strength	Resistenza trazione Tensile Strength
4	4 - 5.5	8 12 16	max 4 max 8 max 12	12	1.5	4008 4012 4016	120 Kg. - 1177 N	180 Kg. - 1765 N
4.8	5 - 6.5	10 16 20	max 5 max 11 max 15	14	1.7	4810 4816 4820	170 Kg. - 1667 N	245 Kg. - 2403 N

+ / - 10%

+ / - 10%

D mm	 mm	L mm	S mm	T mm	K mm	Codice Code	Resistenza al taglio Shear Strength	Resistenza trazione Tensile Strength
3.2	3.3 - 4	9 12	max 6 max 9	6.5	0.85	3209 3212	110 Kg. - 1079 N	165 Kg. - 1618 N
4	4 - 4.5	8 12 16	max 4 max 8 max 12	8	1.2	4008 4012 4016	180 Kg. - 1766 N	260 Kg. - 2550 N
4.8	5 - 6.5	10 16 20 25	max 5 max 11 max 15 max 20	9.5	1.4	4810 4816 4820 4825	320 Kg. - 3140 N	460 Kg. - 4512 N

+ / - 10%

+ / - 10%

SST....MG

MULTI GRIP

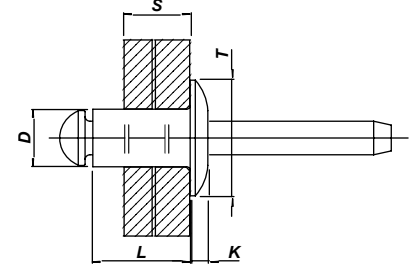

ACCIAIO
STEEL

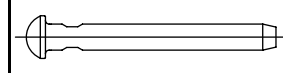

ACCIAIO
STEEL



TONDA
DOMED





DEFREMM



Via Goito, 6 23900 Lecco (LC) - ITALY
TEL. (+39) 0341 251410
FAX (+39) 0341 251411
www.defremm.it